

# FK16VS-5

HIGH-SPEED SWITCHING USE

## FK16VS-5



- $V_{DSS}$  ..... 250V
- $r_{DS(ON)}$  (MAX) .....  $0.31\Omega$
- $I_D$  ..... 16A
- Integrated Fast Recovery Diode (MAX.) ..... 150ns

## OUTLINE DRAWING

Dimensions in mm

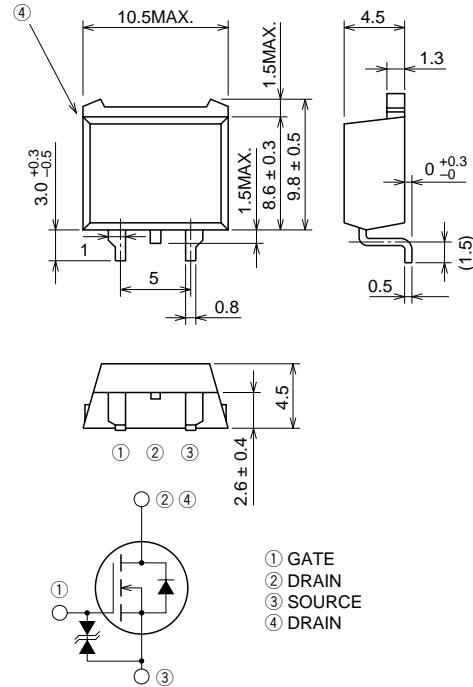

TO-220S

## APPLICATION

Servo motor drive, Robot, UPS, Inverter Fluorecent lamp, etc.

## MAXIMUM RATINGS (Tc = 25°C)

| Symbol    | Parameter                 | Conditions    | Ratings    | Unit |
|-----------|---------------------------|---------------|------------|------|
| $V_{DSS}$ | Drain-source voltage      | $V_{GS} = 0V$ | 250        | V    |
| $V_{GSS}$ | Gate-source voltage       | $V_{DS} = 0V$ | $\pm 30$   | V    |
| $I_D$     | Drain current             |               | 16         | A    |
| $I_{DM}$  | Drain current (Pulsed)    |               | 48         | A    |
| $I_S$     | Source current            |               | 16         | A    |
| $I_{SM}$  | Source current (Pulsed)   |               | 48         | A    |
| $P_D$     | Maximum power dissipation |               | 125        | W    |
| $T_{ch}$  | Channel temperature       |               | -55 ~ +150 | °C   |
| $T_{stg}$ | Storage temperature       |               | -55 ~ +150 | °C   |
| —         | Weight                    | Typical value | 1.2        | g    |

**ELECTRICAL CHARACTERISTICS** (T<sub>ch</sub> = 25°C)

| Symbol                 | Parameter                        | Test conditions                                                                                              | Limits                                    |      |      | Unit |
|------------------------|----------------------------------|--------------------------------------------------------------------------------------------------------------|-------------------------------------------|------|------|------|
|                        |                                  |                                                                                                              | Min.                                      | Typ. | Max. |      |
| V (BR) DSS             | Drain-source breakdown voltage   | I <sub>D</sub> = 1mA, V <sub>GS</sub> = 0V                                                                   | 250                                       | —    | —    | V    |
| V (BR) GSS             | Gate-source breakdown voltage    | I <sub>G</sub> = ±100μA, V <sub>DS</sub> = 0V                                                                | ±30                                       | —    | —    | V    |
| I <sub>GSS</sub>       | Gate-source leakage current      | V <sub>GS</sub> = ±25V, V <sub>DS</sub> = 0V                                                                 | —                                         | —    | ±10  | μA   |
| I <sub>DSS</sub>       | Drain-source leakage current     | V <sub>DS</sub> = 250V, V <sub>GS</sub> = 0V                                                                 | —                                         | —    | 1    | mA   |
| V <sub>GS</sub> (th)   | Gate-source threshold voltage    | I <sub>D</sub> = 1mA, V <sub>DS</sub> = 10V                                                                  | 2                                         | 3    | 4    | V    |
| r <sub>DS</sub> (ON)   | Drain-source on-state resistance | I <sub>D</sub> = 8A, V <sub>GS</sub> = 10V                                                                   | —                                         | 0.24 | 0.31 | Ω    |
| V <sub>DS</sub> (ON)   | Drain-source on-state voltage    | I <sub>D</sub> = 8A, V <sub>GS</sub> = 10V                                                                   | —                                         | 1.92 | 2.48 | V    |
| y <sub>fs</sub>        | Forward transfer admittance      | I <sub>D</sub> = 8A, V <sub>DS</sub> = 10V                                                                   | 6.5                                       | 10.0 | —    | S    |
| C <sub>iss</sub>       | Input capacitance                | V <sub>DS</sub> = 25V, V <sub>GS</sub> = 0V, f = 1MHz                                                        | —                                         | 1050 | —    | pF   |
| C <sub>oss</sub>       | Output capacitance               |                                                                                                              | —                                         | 220  | —    | pF   |
| C <sub>rss</sub>       | Reverse transfer capacitance     |                                                                                                              | —                                         | 45   | —    | pF   |
| t <sub>d</sub> (on)    | Turn-on delay time               |                                                                                                              | —                                         | 20   | —    | ns   |
| t <sub>r</sub>         | Rise time                        | V <sub>DD</sub> = 150V, I <sub>D</sub> = 8A, V <sub>GS</sub> = 10V, R <sub>GEN</sub> = R <sub>GS</sub> = 50Ω | —                                         | 40   | —    | ns   |
| t <sub>d</sub> (off)   | Turn-off delay time              |                                                                                                              | —                                         | 110  | —    | ns   |
| t <sub>f</sub>         | Fall time                        |                                                                                                              | —                                         | 50   | —    | ns   |
| V <sub>SD</sub>        | Source-drain voltage             |                                                                                                              | I <sub>S</sub> = 8A, V <sub>GS</sub> = 0V | —    | 1.5  | 2.0  |
| R <sub>th</sub> (ch-c) | Thermal resistance               | Channel to case                                                                                              | —                                         | —    | 1.00 | °C/W |
| t <sub>rr</sub>        | Reverse recovery time            | I <sub>S</sub> = 16A, di <sub>s</sub> /dt = -100A/μs                                                         | —                                         | —    | 150  | ns   |

**PERFORMANCE CURVES**

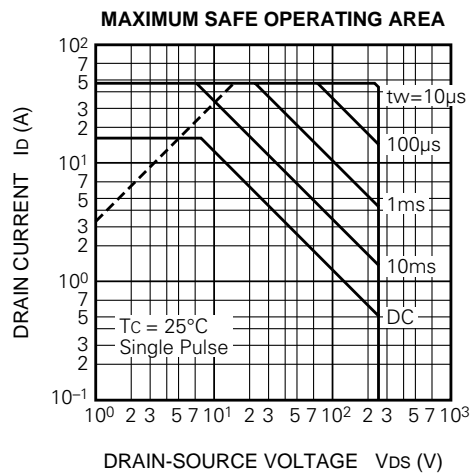
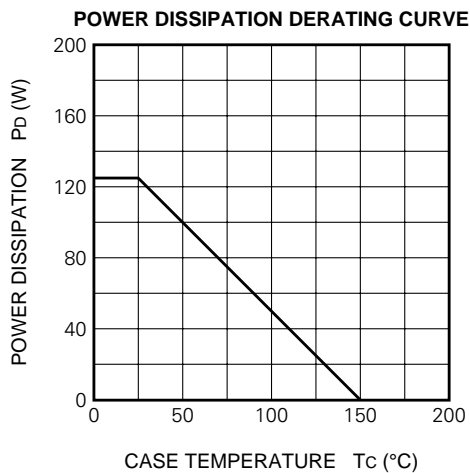

OUTPUT CHARACTERISTICS (TYPICAL)

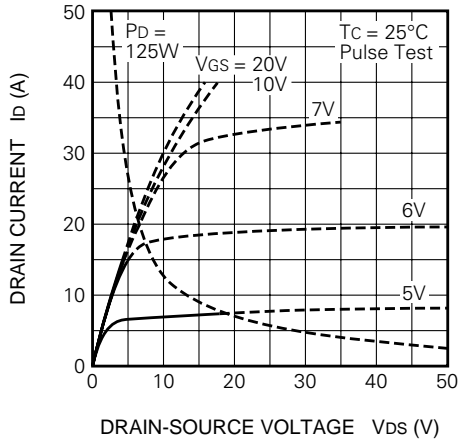

OUTPUT CHARACTERISTICS (TYPICAL)

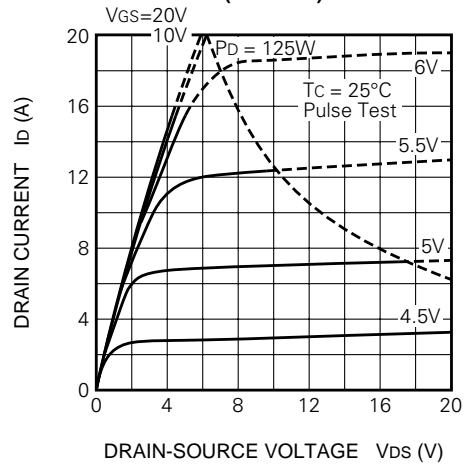

ON-STATE VOLTAGE VS. GATE-SOURCE VOLTAGE (TYPICAL)

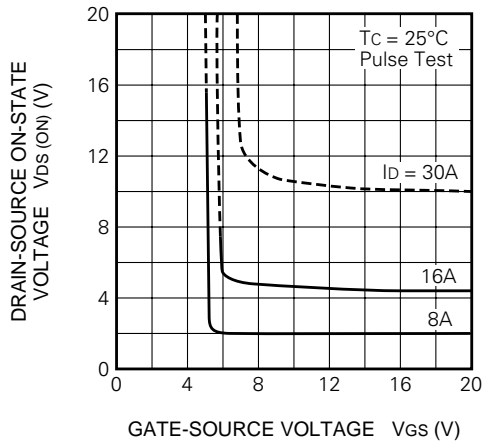

ON-STATE RESISTANCE VS. DRAIN CURRENT (TYPICAL)

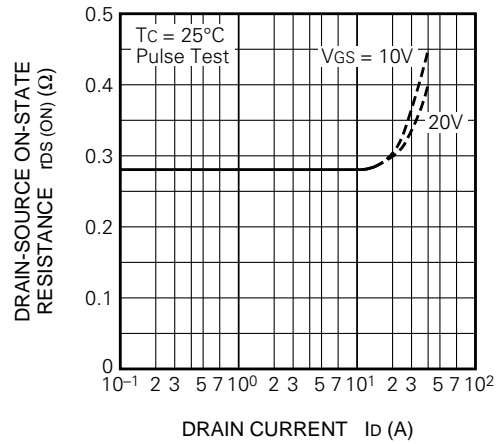

TRANSFER CHARACTERISTICS (TYPICAL)

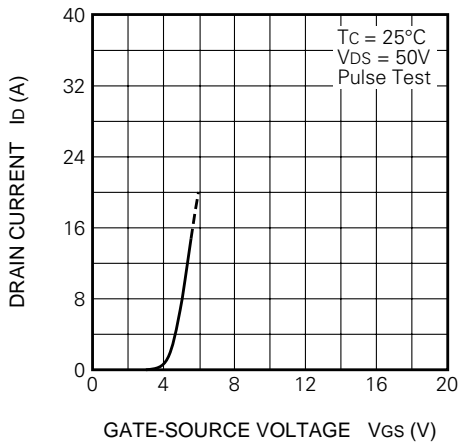

FORWARD TRANSFER ADMITTANCE VS. DRAIN CURRENT (TYPICAL)

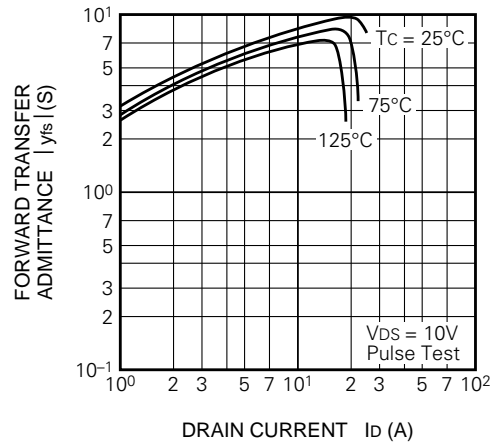

**CAPACITANCE VS. DRAIN-SOURCE VOLTAGE (TYPICAL)**

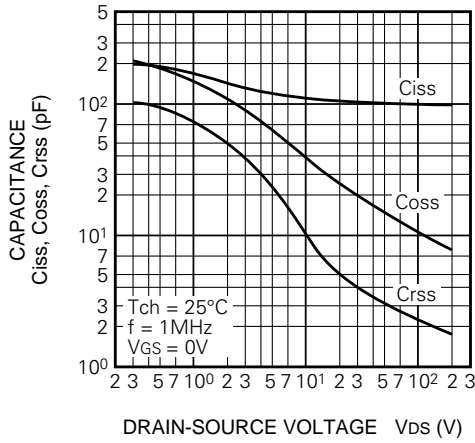

**SWITCHING CHARACTERISTICS (TYPICAL)**

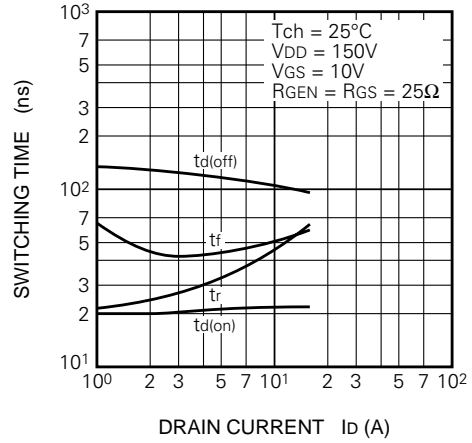

**GATE-SOURCE VOLTAGE VS. GATE CHARGE (TYPICAL)**

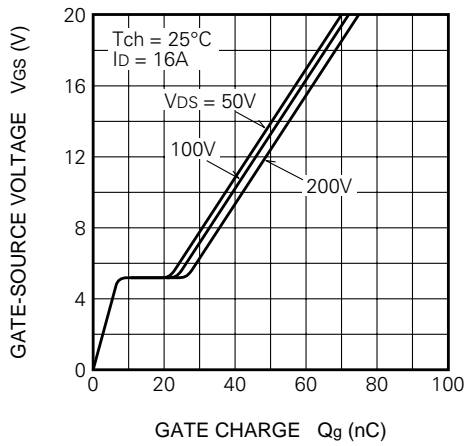

**SOURCE-DRAIN DIODE FORWARD CHARACTERISTICS (TYPICAL)**

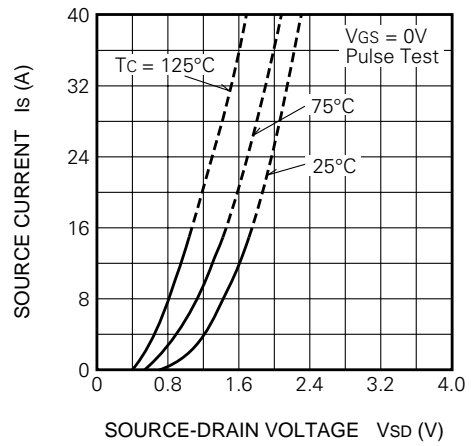

**ON-STATE RESISTANCE VS. CHANNEL TEMPERATURE (TYPICAL)**

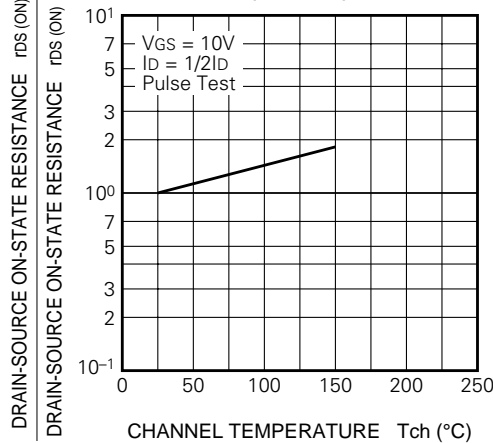

**THRESHOLD VOLTAGE VS. CHANNEL TEMPERATURE (TYPICAL)**

